



Company profile

# Out Line S.R.L.

**Address:**

Via degli Olmetti 39D  
00060 Formello (RM)

**Phone:**

+39 0690405273

**Email:**

[info@outline.company](mailto:info@outline.company)

**Web:**

[www.outline.company](http://www.outline.company)

# About us

Out Line S.r.l.



Out Line DNA is based on more than thirty years of experience in energy and telecommunications technologies evolution. Its Head Quarter, warehouse and production is located near Rome, Italy, Out Line can rely on strategic partners and consultants spread all over the world along with own personnel in China.

Through the years, Out Line has evolved and started creating innovative solutions as result of the networks evolution understanding and specific intimacy at R&D, Marketing, Procurement and Business End Users level.

In the Telecom and Energy markets such level of intimacy can generate a design differentiation and this is a key success factor that lead to the competitive advantage in the respective field of competencies.

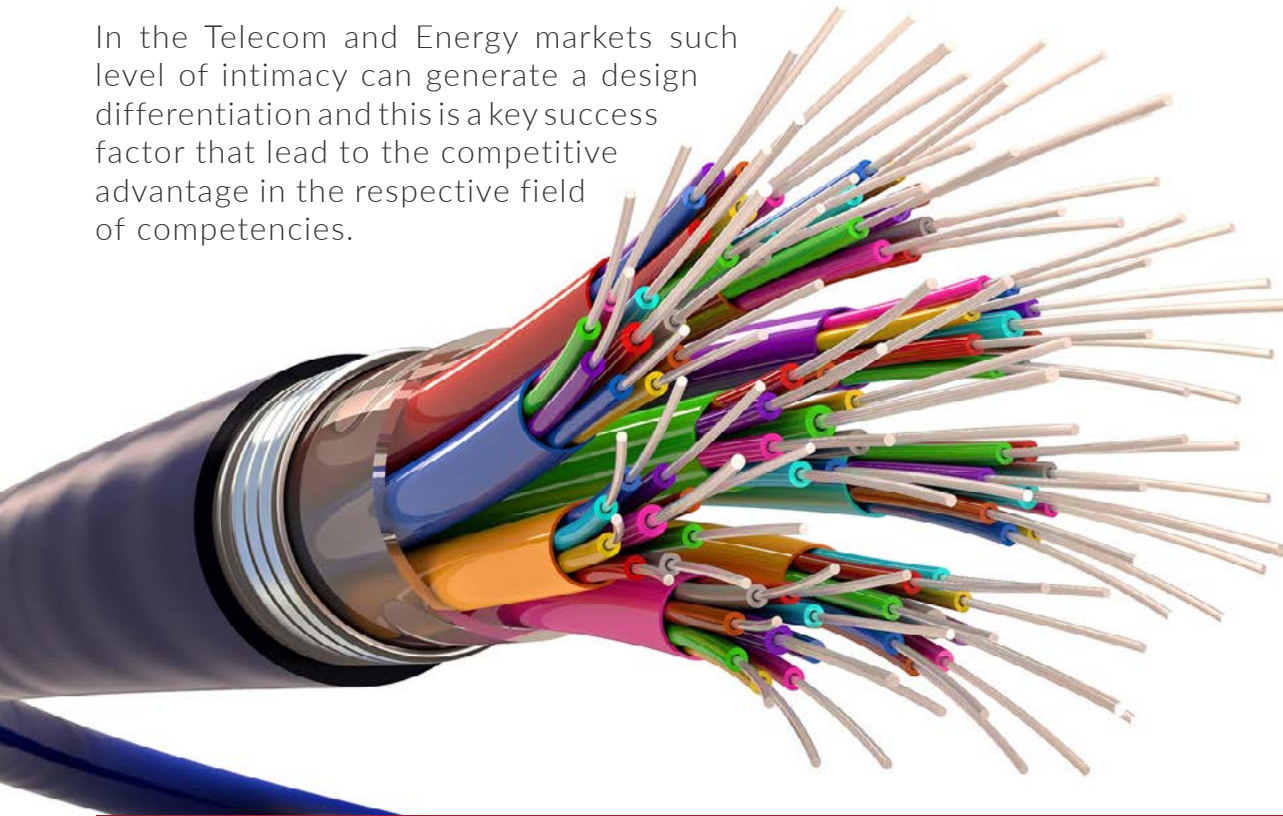

Fundamental policy of Out Line is to fulfill the requirements of customers beyond their expectations. In this context, our main goal is to design affordable, practical and reliable products with our extensive experience and knowledge, to produce them accurately on time and to offer high quality after-sale service.

All our employees strive to perform their duties correctly, excellently, and on time during all processes and activities in accordance with the continuous improvement principle with respect to our environment.

Our main principle is to work based on the motto 'All groups are responsible for quality and environmental efforts' by creating a participative, quality-oriented and open-for-change environment together with all our employees.

Accordingly, we consider that performing quick, efficient and economic productions in a way that ensures customer satisfaction in accordance with legislations and environmental awareness is the first and most significant indicator of success.

In the R&D laboratory, our team of technicians and designers deeply understands customer needs and develops a consistent proposal with demand and expectations, plus the added value that comes from high expertise and professionalism of the staff, while our logistic staff guarantees the delivery of standard products in a very short time

# Our History

Out Line S.r.l.

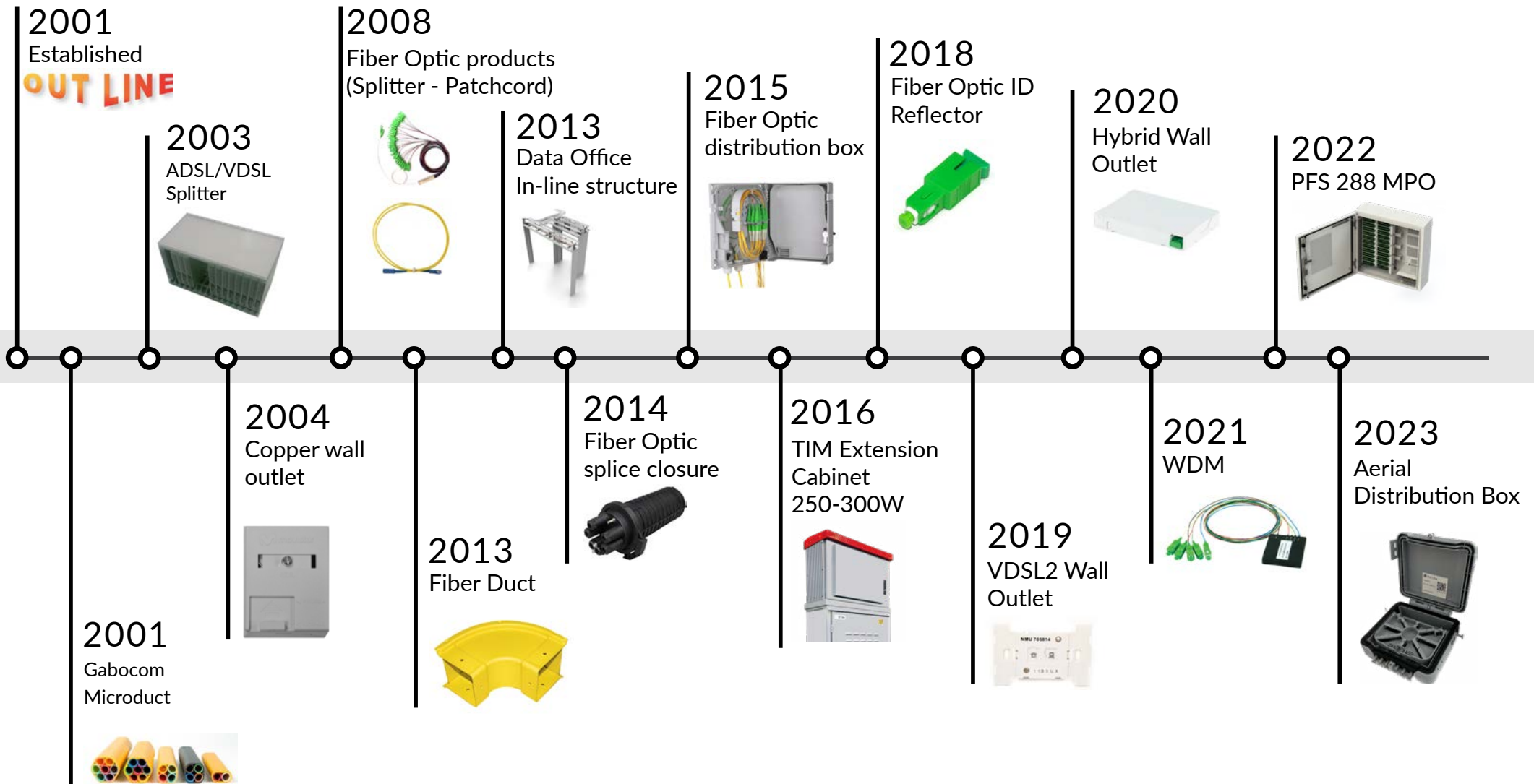

# Our Office

Out Line S.r.l.

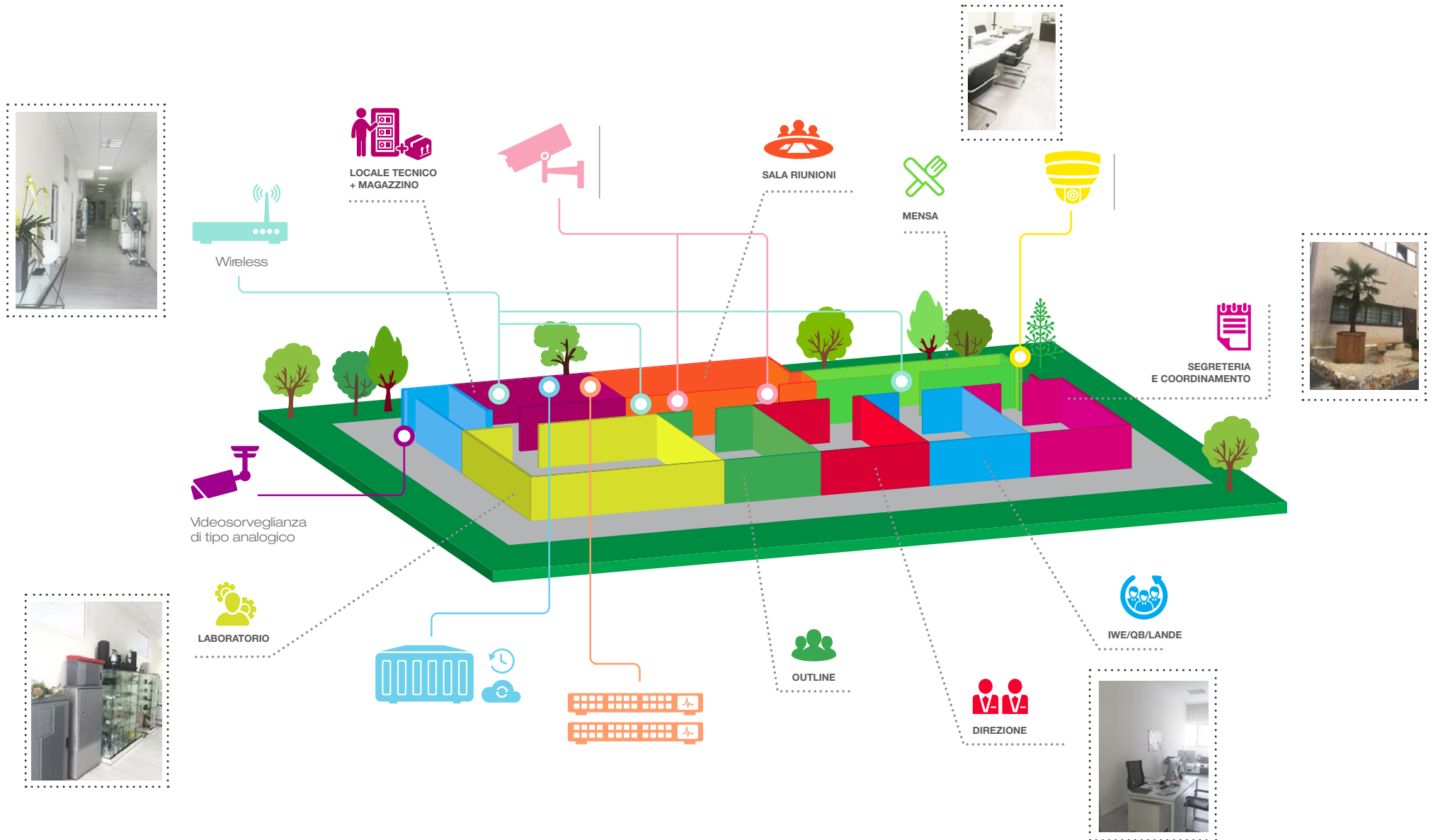

# Our Contacts

Out Line S.r.l.

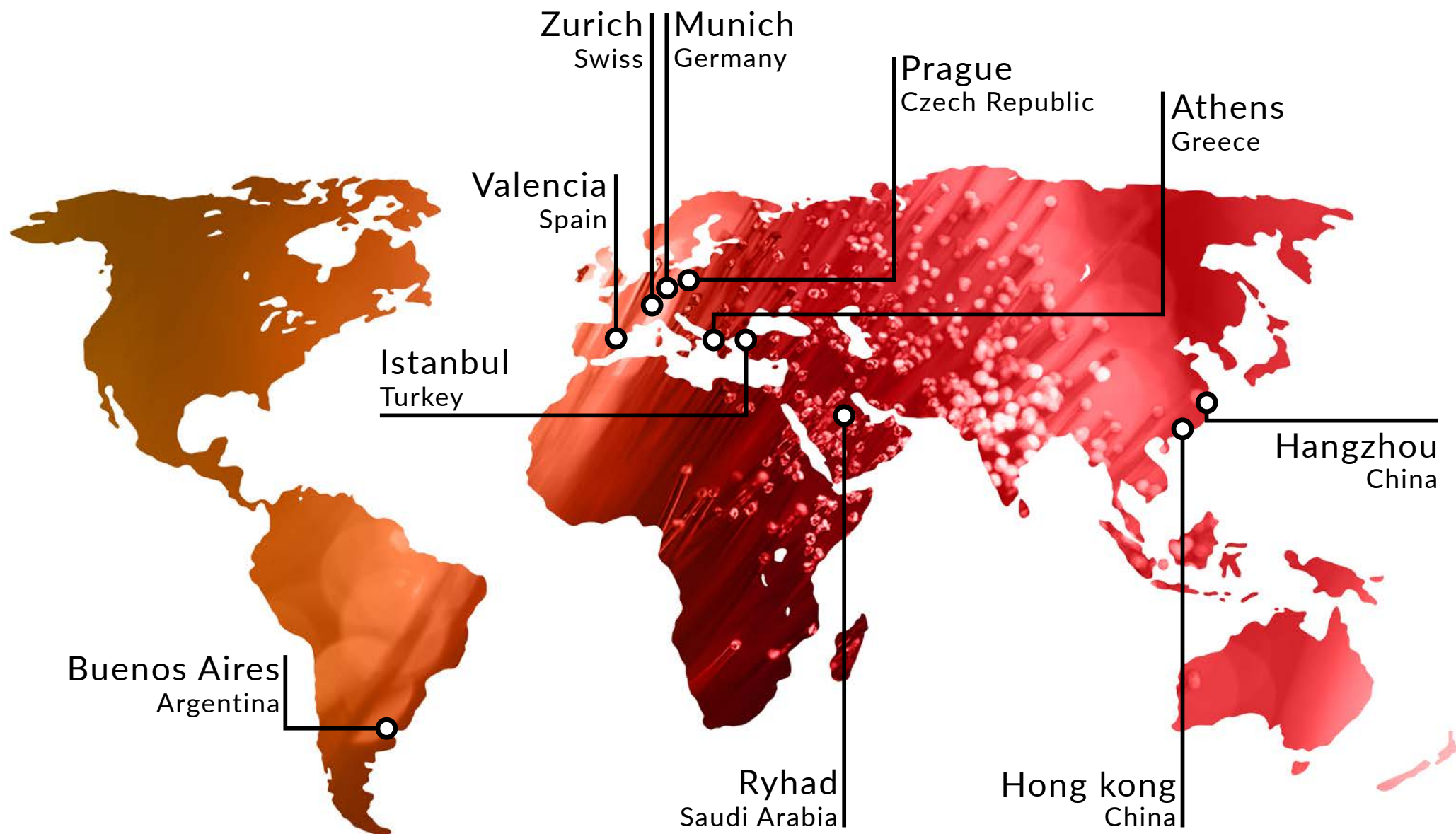



# Main Customers

Out Line S.r.l.



# Main Partners



# Our R&D Department

Out Line S.r.l.





# Our R&D Department

Out Line S.r.l.

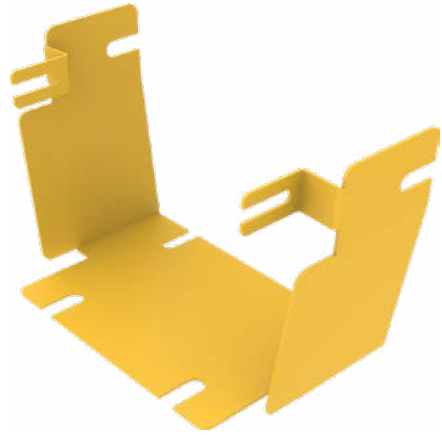

Fiber Duct Adapter Outline Panduit



PTE BT XL

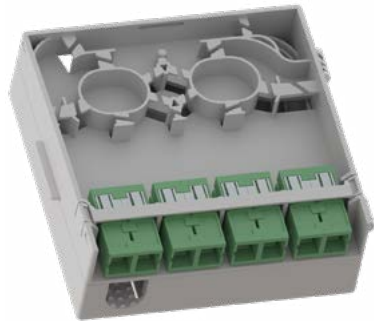

CDP



U-Shape

# Our R&D Department

Out Line S.r.l.

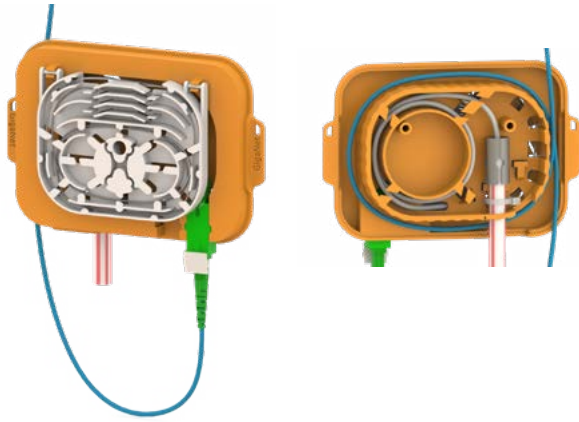

Holder for Splice Tray



Floor Distribution Box

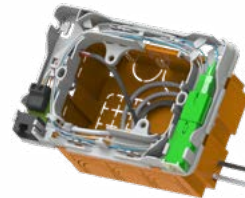

Wall Outlet Frame



PTE

# Our R&D Department

Out Line S.r.l.



FO Manager



ODF



PFS 288



Multi Operator Box



PFS 144



Ducts Structure

Lined writing area with horizontal lines.

# Our Products

Out Line S.r.l.

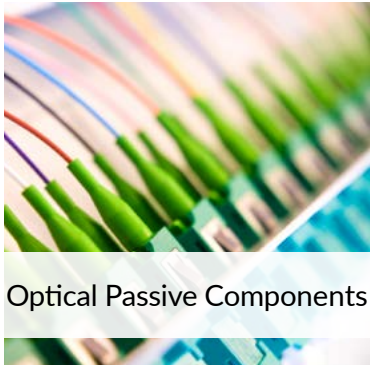

Optical Passive Components



Fiber Optic Cable

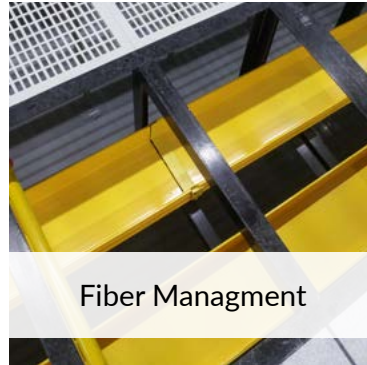

Fiber Management

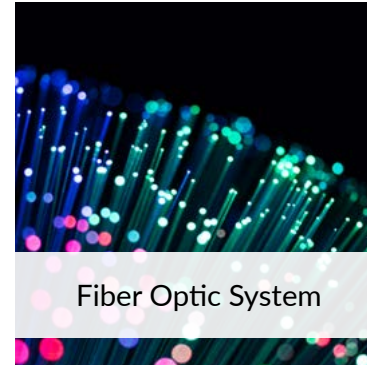

Fiber Optic System



Fiber Optic Closure

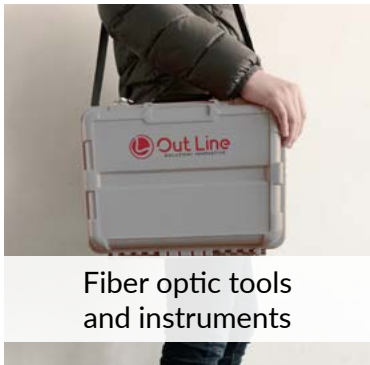

Fiber optic tools and instruments



Silway - FTTR System



Rack and Cabinet



Microducts

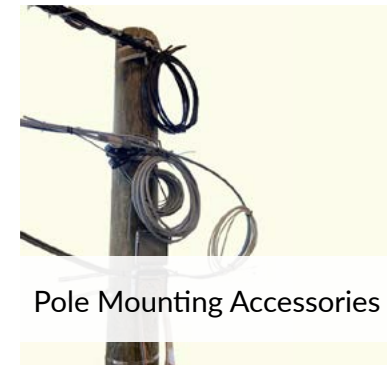

Pole Mounting Accessories



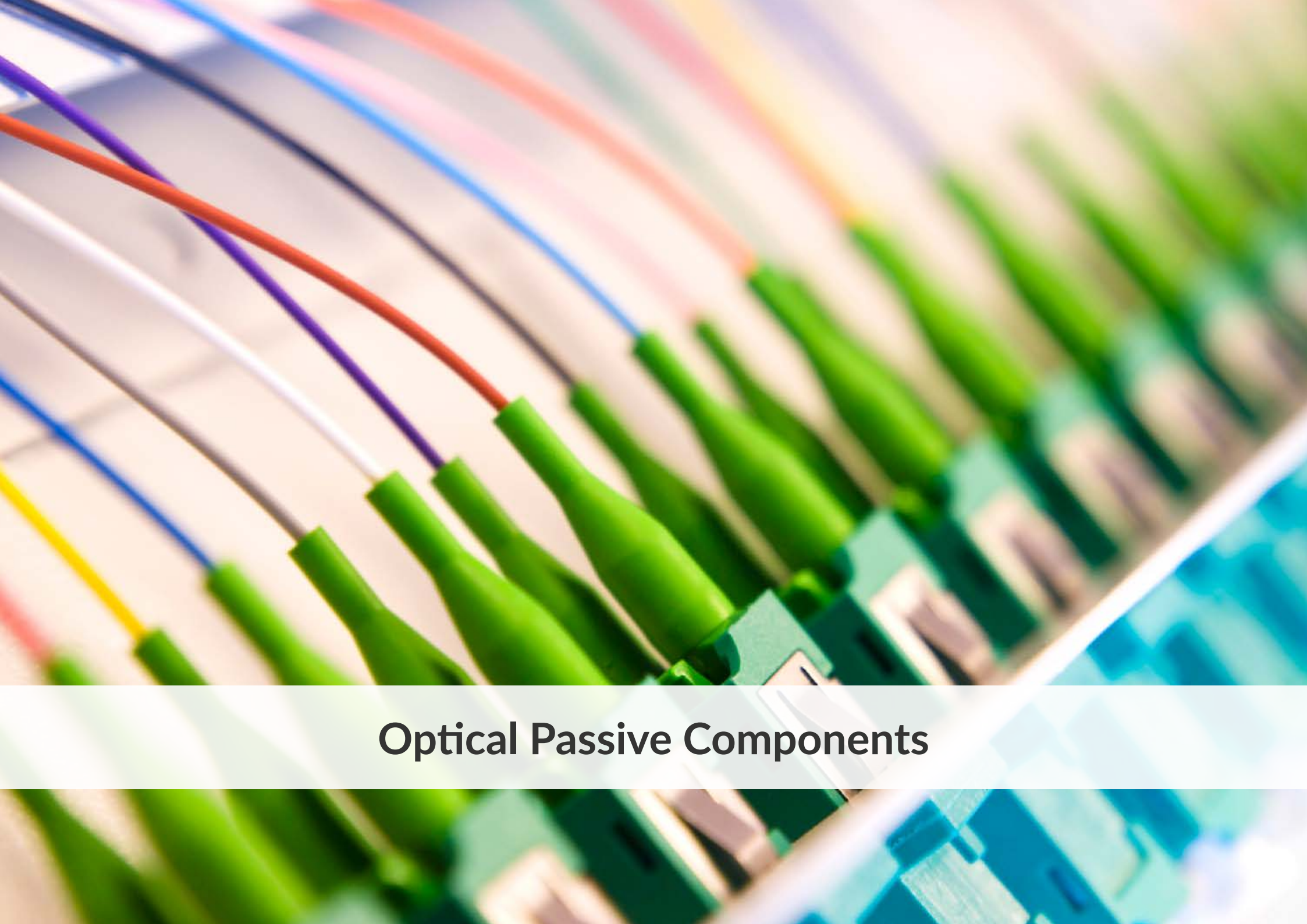

## **Optical Passive Components**





## Patch Cord

- FIBER OPTIC PATCHCORD
- FIBER OPTIC FAN-OUT AND TRUNK
- MPO PATCHCORD
- SPRING PATCHCORD
- PATCHCORD SC/APC - SC/APC
- OUT-T-PATCHCORD

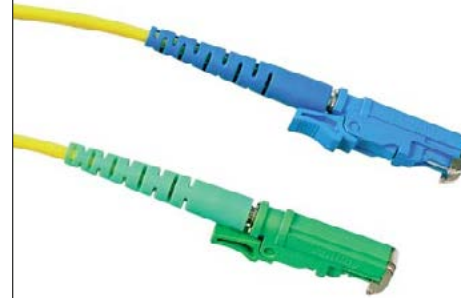

## Pigtail Connector

- FIBER OPTIC PIGTAIL.
- PIGTAIL WITH FBG 1650NM U BAND REFLECTOR EMBEDDED



## WDM

- TIM: WDM GPON / XGS-PON CEX FILTER
- ENEL: WDM OTDR RING

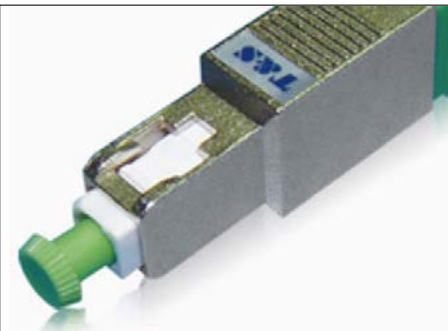

## U-Band Reflector

- U-BAND REFLECTOR
- RIFLETTORI FBG MONODIREZIONALI
- RIFLETTORI FBG BIDIREZIONALI
- PIGTAIL WITH FBG 1650NM U BAND REFLECTOR EMBEDDED



## Adapter

- FIBER OPTIC ADAPTER

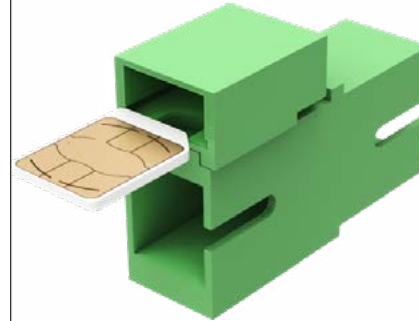

## Smart Adapter

- SM@D - SMART ADAPTER SYSTEM FOR USER RECOGNITION IN THE FIBER OPTICAL CABINETS



## Attenuator

- FIBER OPTIC ATTENUATOR

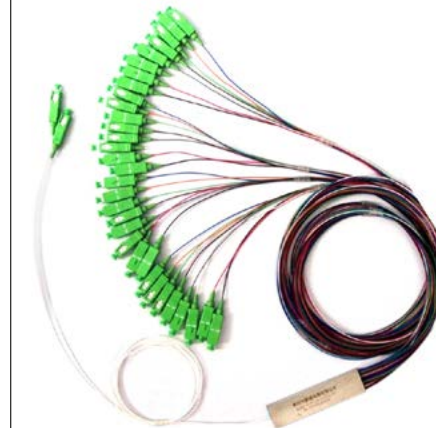

## PLC Splitter

- 1XN & 2XN PLC SPLITTER
- MINI STEEL TUBE PLC SPLITTER
- 1XN & 2XN PLC SPLITTER
- PLC PRIMARY SPLITTER
- COMPACT SC/APC
- PRECONNECTORIZED PLC SPLITTER



**WDM**

- WAVELENGTH DIVISION MULTIPLEXING STEINLESS STEEL CASE
- WAVELENGTH DIVISION MULTIPLEXING PLASTIC CASE



**Mechanical Splice**

- FIBER OPTIC MECHANICAL SPLICE



**Mechanical Connector**

- MECHANICAL FIBER OPTIC CONNECTOR PRE-EMBEDDED TECH



**Splice-on Connector (SOC)**

- WAVELENGTH DIVISION MULTIPLEXING STEINLESS STEEL CASE
- WAVELENGTH DIVISION MULTIPLEXING PLASTIC CASE





## Fiber Optical Cables



## FRP Cables 1/2 Fibers

- FRP CABLES 1/2 FIBERS

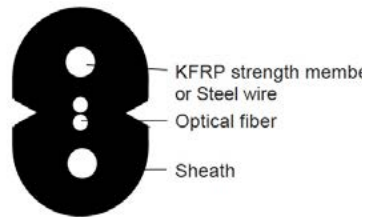

## FRP Cables 8 Fibers

- FRP-CABLE-8-FIBERS

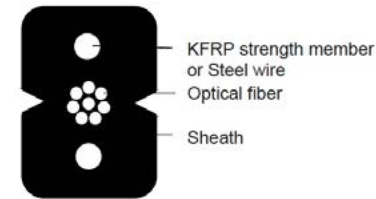

## ADSS Cables

- 48..72 FIBERS  
- 96 FIBERS  
- 144 FIBERS  
- 192 FIBERS



## ADSS Drop Cables

- 24..48 FIBERS  
- 4..12 FIBERS

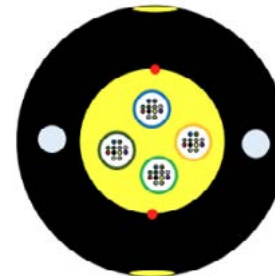





## Fiber Management



# Fiber Management

Out Line S.r.l.

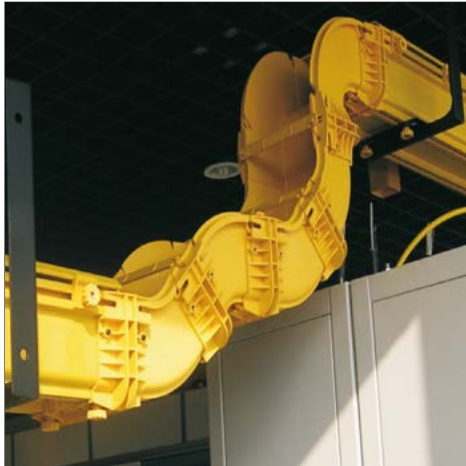

## Fiber Optic Cable Ducts

- CABLE DUCT
- DUCT ACCESSORIES
- ADAPTER TO PANDUIT
- ADAPTER TO ADC KRONE

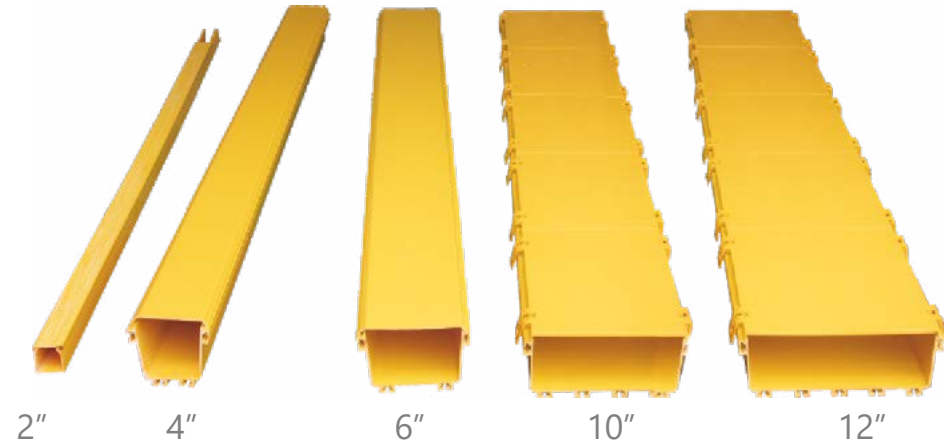



**Fiber Optic System - FTTH**



## Wall Outlet

- 1 FO WALL OUTLET
- 2 FO WALL OUTLET
- 4 FO WALL OUTLET



## PTE BOXES

- 12 FO
- 24 FO
- 48 FO
- 72 FO



## Frame Wall Outlet

- 1 FO WALL OUTLET
- 1 RJ11 INPUT



## FTTH Accessories

- PRIMARY DIVIDER
- COMPACT FLOOR BOX
- SECONDARY DIVIDER



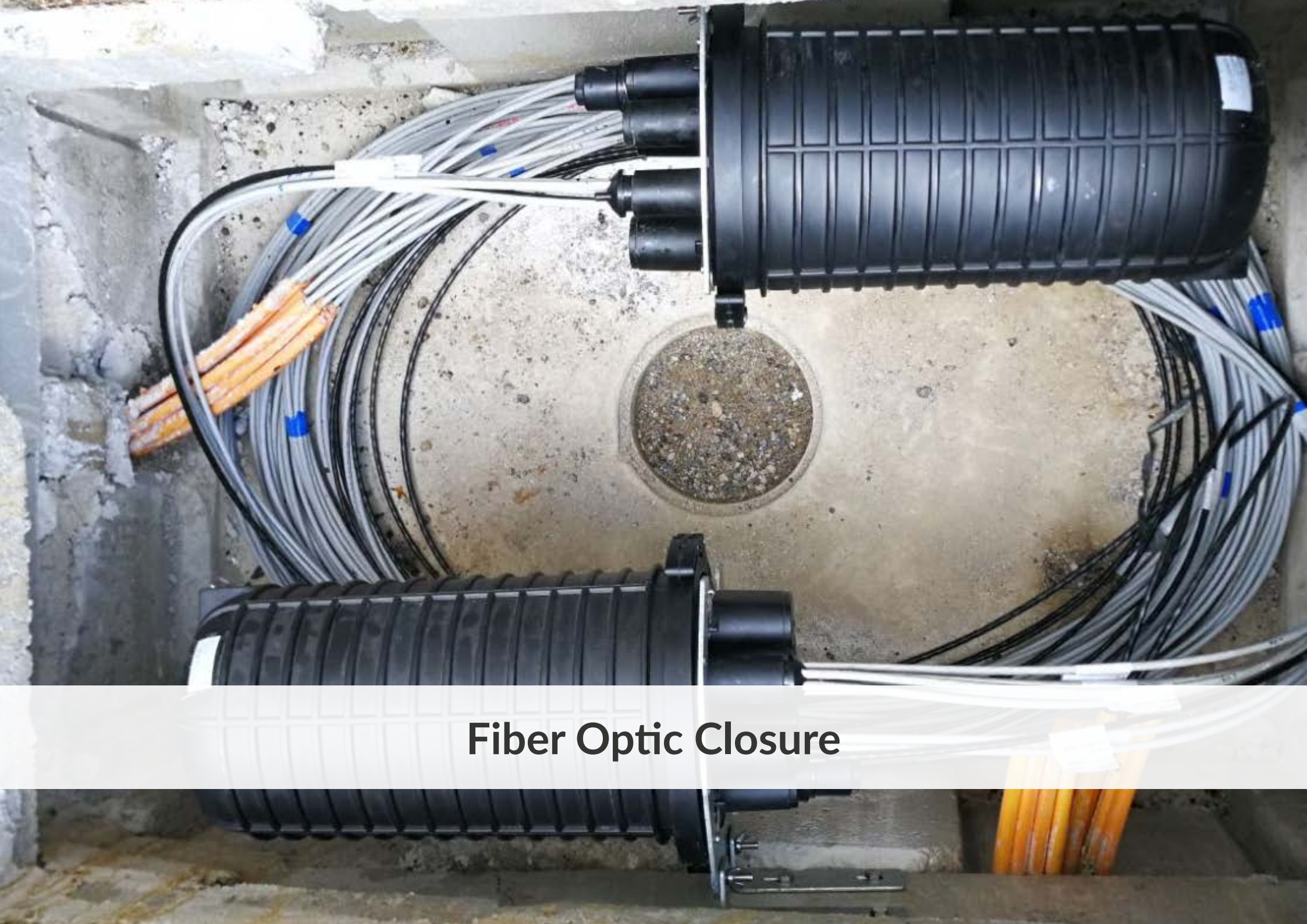

**Fiber Optic Closure**



## Single Element (Fosc Type)

- SPLICE TRAYS AVAILABLE
- MINI CLOSURE
- BASES AVAILABLE



## Single Circuit (Fist Type)

- ROUND CLOSURE
- SQUARE CLOSURE
- CUSTOMIZED CLOSUR

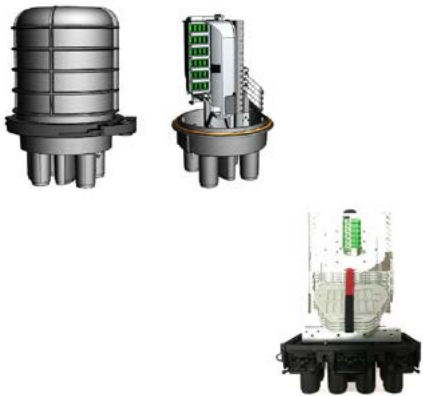

## Single Circuit Point of Flexibility (Fist Type)

- ROUND CLOSURE
- SQUARE CLOSURE

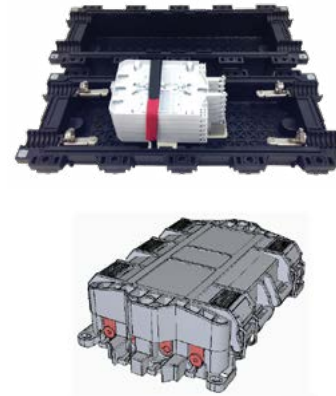

## Inline Closure

- STANDARD INLINE CLOSURE
- CUSTOMIZED OF INLINE CLOSURE





## Fiber Optic Tools and Instruments





## Full Case for Jointers

---

- FIBER OPTICS - FULL CASE FOR JOINTERS



## Cutting and Stripping Tools

---

- CUTTING AND STRIPPING TOOLS



## Polishing Tools

---

- POLISHING TOOLS\_DATASHEET



## Measuring Instruments OTDR

---

- FIBER OPTICS - MEASURING INSTRUMENTS OTDR



## Easy Splicer

---

- EASY SPLICER



## 740 FTTx Fusion Splicer

---

- 740 FTTX FUSION SPLICER



## OTDR

---

- MEASURE DISTANCE FROM 0 TO 60 KM, IN RESOLUTION OF 1M
- MEASURE DB LOSS WITH A RESOLUTION OF 0.01 DB
- AUTO MODE FOR SUPER EASY OPERATION (AND EXPERT MODE FOR EXPERTS).
- 4.3 INCH, MULTI COLOR LED, TOUCH SCREEN





## **SILWAY - FTTR SYSTEM**

# SILWAY - FTTR System

Out Line S.r.l.



## SILWAY

Designed and created by Out Line, SILWAY allows you to bring the optical fiber to every point of the apartment. The small and transparent profile allows you to pass the fiber in a simple and clean way where it is not possible to use the existing electrical system.

SILWAY guarantees the correct curvature of the optical fiber even in the presence of edges and corners.

This system allows everybody to create a protective path for cables in general up to 2.5mm in diameter with a minimum visual impact. Particularly it was designed for optical fibers.

The need arises from the frequent obstruction of junction boxes and corrugated pipes that do not allow the passage of delicate fiber optic cables.

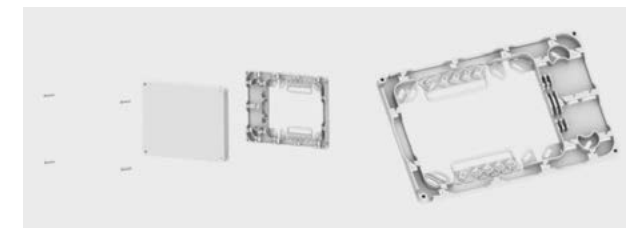
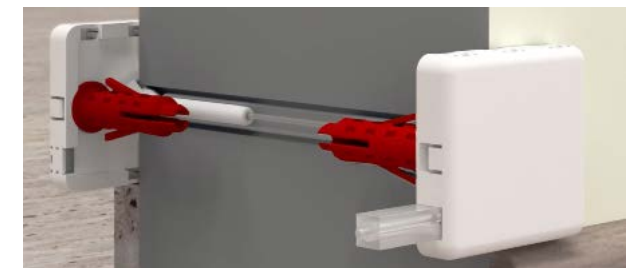
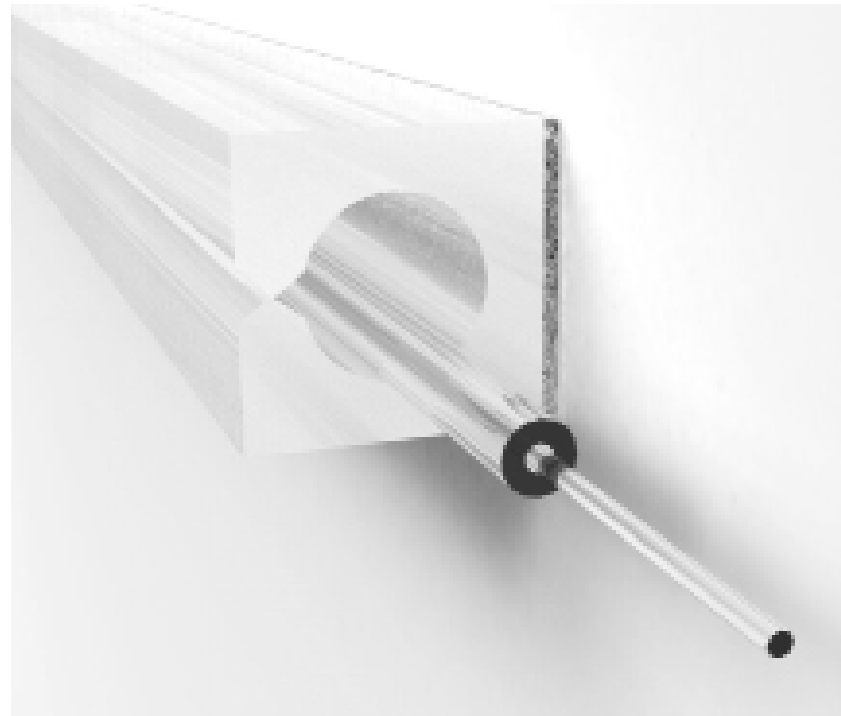

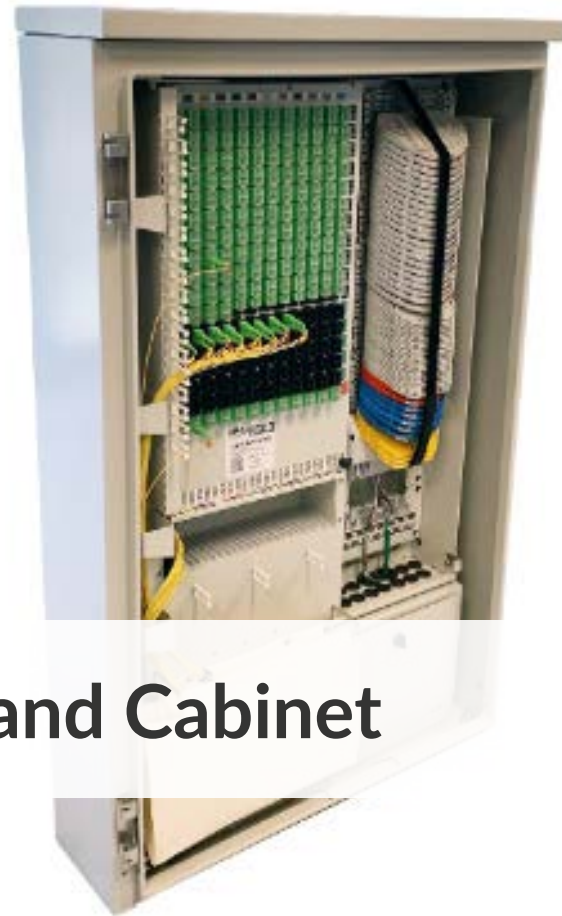

**Fiber Optic Rack and Cabinet**



# Fiber Optic Rack and Cabinet

Out Line S.r.l.



## ODF Rack

---

- DATA ROOM RACK  
900X300X2.200 MM
- DATA ROOM CABINET  
1.200X300X2.200 MM



## ETSI N3 Rack

---

- DATA ROOM RACK  
600X300X2200MM



## Junction/Termination Subtrack

---

### Up to 96 optical fibers

- PRE-CABLED SOLUTION



## Junction/Termination Subtrack

---

### Up to 48 optical fibers

- EMPTY SOLUTION

# Fiber Optic Rack and Cabinet

Out Line S.r.l.



## Outdoor street cabinet for up to 256 users

- PFS4 OPEN FIBER 256U SC/APC CONFIGURATION
- CNO INFRATEL 256U SC/APC CONFIGURATION
- SCP PPC 256U SC/APC CONFIGURATION



## Outdoor street cabinets for up to 576 users

- CRO FIBERCOP 384U SC/APC CONFIGURATION
- CRO FIBERCOP 576U SC/APC CONFIGURATION



## Outdoor Pole/Wall cabinet for up to 288 users

- PFS 144U SC/APC CONFIGURATION
- PFS 288U SC/APC (WITH MPO CONNECTORS) CONFIGURATION
- NEW SCP 256U SC/APC POLE/STREET MOUNTING



## Outdoor street cabinets for up to 128 users

- MINI-CRO FIBERCOP 128U SC/APC CONFIGURATION
- MINI-PFS 144U LC/APC CONFIGURATION

# Fiber Optic Rack and Cabinet

Out Line S.r.l.



The image shows a tall, grey metal cabinet with a red top section. It has a door on the front with a yellow label and a small logo. The cabinet is designed for outdoor use.

## Extension Cabinet FTTC for outdoor

---

- FTTC EXTENSION CABINET 250W
- FTTC EXTENSION CABINET 300W



The image shows two views of a grey metal cabinet. On the left is the closed cabinet. On the right is the cabinet with its door open, revealing internal components like fiber optic ports and wiring.

## DSLAM Cabinet indoor

---

- DSLAM CABINET MEDIUM
- DSLAM CABINET LARGE



## Microducts and Accessories







## Micro Ducts

- SPEED PIPE
- BUNDLES
- FENDER



## Junction

- 7 MM
- 10 MM
- 12 MM
- 14 MM
- 16 MM
- OTHER MEASURES UPON REQUEST



## Cap

- 7 MM
- 10 MM
- 12 MM
- 14 MM
- 16 MM
- OTHER MEASURES UPON REQUEST



## Reducer

- 14/12 MM
- 12/10 MM
- OTHER MEASURES UPON REQUEST

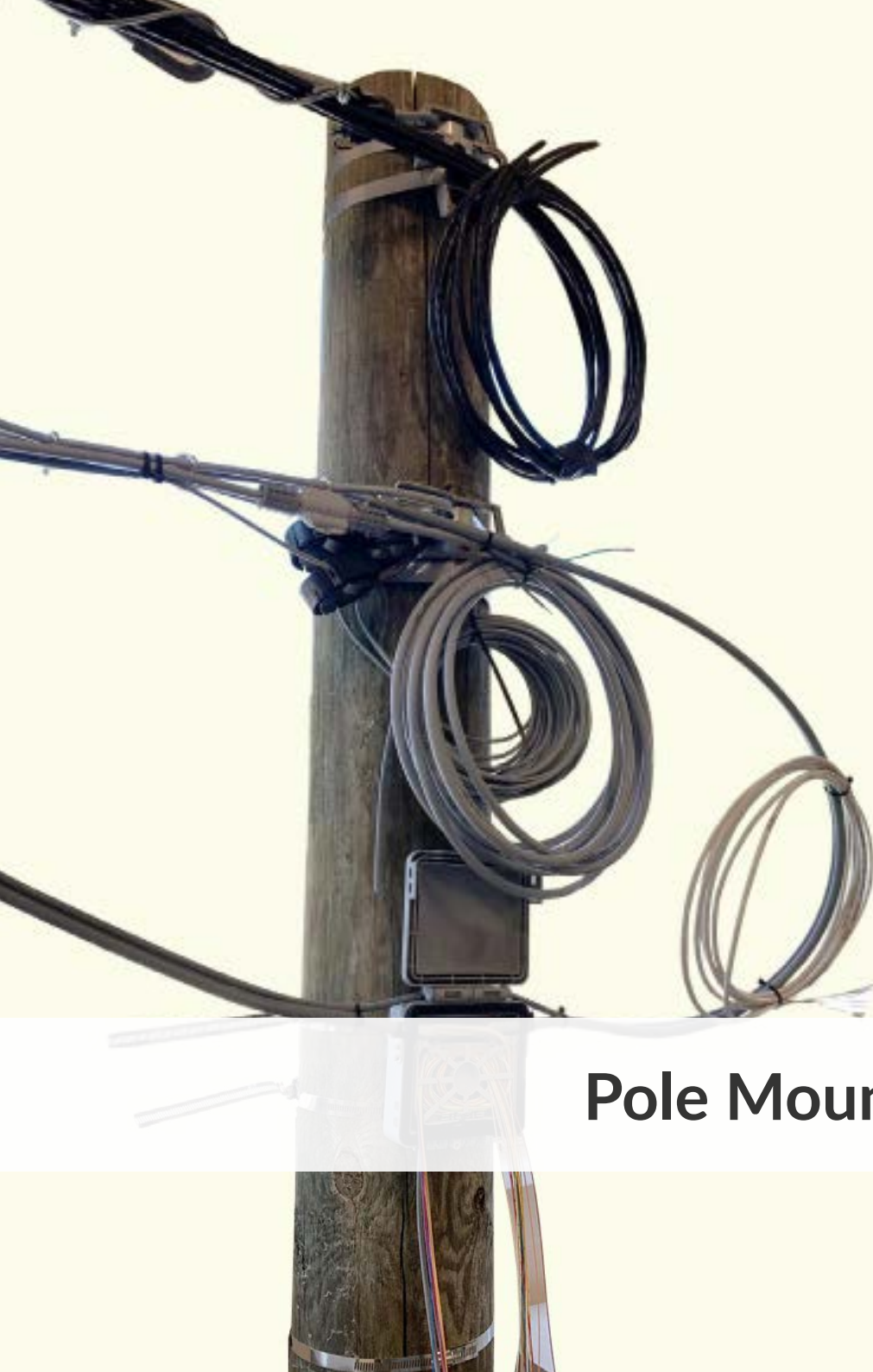

## Pole Mounting Accessories



## 2/4 PTE Light IP55

- FIBER DISTRIBUTION BOX FOR 2/4 UI FOR AERIAL OR WALL INSTALLATION



## 6PTE Light IP55

- FIBER DISTRIBUTION BOX FOR 6 UI FOR POLE OR WALL INSTALLATION

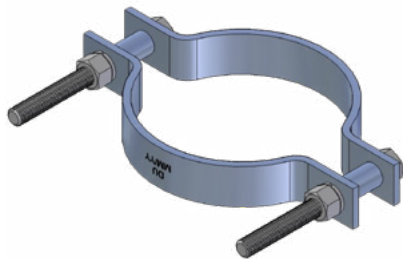

## Steel Collar

- THE ELLIPTICAL COLLAR IS PLACED ON TOP OF THE FIBERGLASS POLES AND WOODEN POLES. IT PERFORMS THE TASK OF CONNECTING ACCESSORIES SUCH AS THE CHAIN TENSIONER.

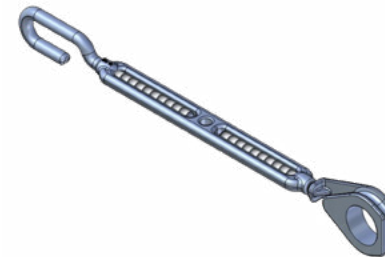

## Metallic Tie-Rod with integrated thimble

- THE HOOK FOR ANCHORING TO THE POLE RING AND THE INTEGRATED THIMBLE THAT ALLOWS THE PASSAGE OF THE ANCHORING CLAMP.

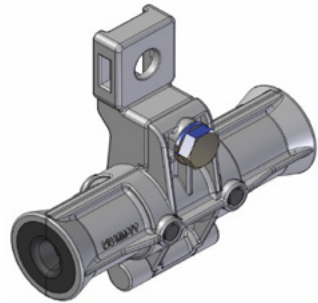

## Accessories for Suspension TYPE A

- THE TYPE A SUSPENSION DEVICE IS SUITABLE FOR SUPPORTING THE SELF-SUPPORTING OPTICAL CABLE WITH A DIAMETER OF  $13\pm 0.5$  MM TO THE SUPPORT POLES WITHOUT TENSION OR WITH LIMITED AXIAL TENSIONS AND ENSURES THE ANCHORING OF THE CABLE.



## Accessories for Suspension OF

- THE OPEN FIBER SUSPENSION DEVICE IS SUITABLE FOR SUPPORTING THE SELF-SUPPORTING OPTICAL CABLE WITH A DIAMETER OF  $13\pm 0.5$  MM TO THE SUPPORT POLES WITHOUT TENSION OR WITH LIMITED AXIAL TENSIONS AND ENSURES THE ANCHORING OF THE CABLE.



## Accessory for Mooring

- SUPPORT ELEMENT FOR OVERHEAD LAYING OF CABLES. CONSISTING OF A TIE ROD AND SUCTION FILAMENTS CAPABLE OF WRAPPING AND SUPPORTING THE CABLE.







**Address:**

Out Line S.r.l. via degli Olmetti 39D  
00060 Formello (RM)

**Phone:**

+39 0690405273

**Email:**

[commerciale@outline.company](mailto:commerciale@outline.company)

[www.outline.company](http://www.outline.company)