



Company profile

Out Line S.R.L.

Address:

Via degli Olmetti 39D
00060 Formello (RM)

Phone:

+39 0690405273

Email:

info@outline.company

Web:

www.outline.company

Revision_3.0

Scan of our Catalogs



About us

Out Line S.r.l.



Out Line DNA is based on more than thirty years of experience in energy and telecommunications technologies evolution. Its Head Quarter, warehouse and production is located near Rome, Italy, Out Line can rely on strategic partners and consultants spread all over the world along with own personnel in China.

Through the years, **Out Line** has evolved and started creating innovative solutions as result of the networks evolution understanding and specific intimacy at R&D, Marketing, Procurement and Business End Users level.

In the Telecom and Energy markets such level of intimacy can generate a design differentiation and this is a key success factor that lead to the competitive advantage in the respective field of competencies.

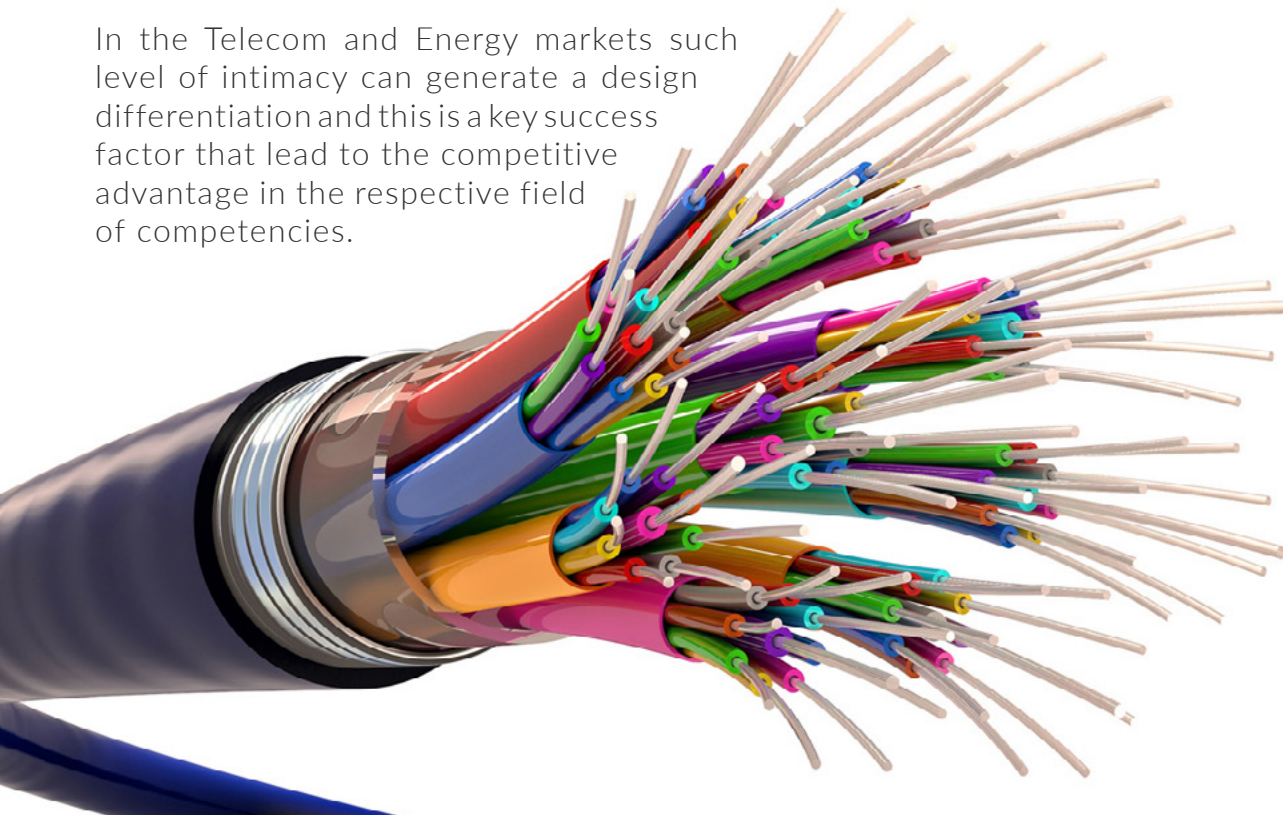

Fundamental policy of **Out Line** is to fulfill the requirements of customers beyond their expectations. In this context, our main goal is to design affordable, practical and reliable products with our extensive experience and knowledge, to produce them accurately on time and to offer high quality after-sale service.

All our employees strive to perform their duties correctly, excellently, and on time during all processes and activities in accordance with the continuous improvement principle with respect to our environment.

Our main principle is to work based on the motto 'All groups are responsible for quality and environmental efforts' by creating a participative, quality-oriented and open-for-change environment together with all our employees.

Accordingly, we consider that performing quick, efficient and economic productions in a way that ensures customer satisfaction in accordance with legislations and environmental awareness is the first and most significant indicator of success.

In the R&D laboratory, our team of technicians and designers deeply understands customer needs and develops a consistent proposal with demand and expectations, plus the added value that comes from high expertise and professionalism of the staff, while our logistic staff guarantees the delivery of standard products in a very short time.

Our History

Out Line S.r.l.

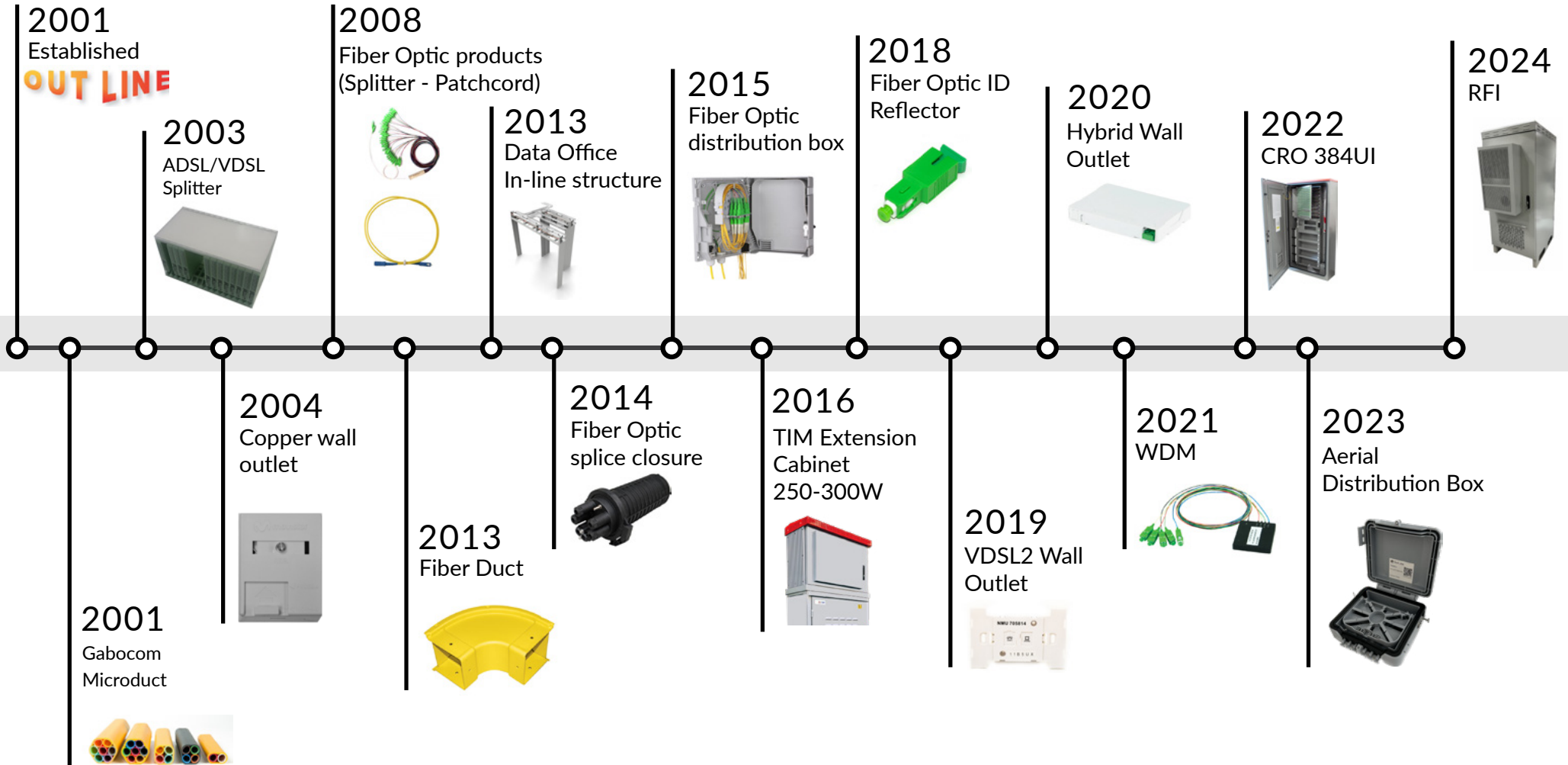

Our Certifications



Out Line S.r.l.

For **Out Line**, international certifications are essential as they represent our commitment to quality, reliability, and continuous improvement.

Our company is compliant to industry standards and best practices, providing our customers with a high level of confidence in products and services.

Additionally, certifications help us maintaining a competitive advantage in the market, and demonstrate our dedication to delivering excellence in every project we are involved.



Dasa-Rägister



Compliant & Certified



Compliant & Certified



Compliant & Certified

Our Contacts

Out Line S.r.l.

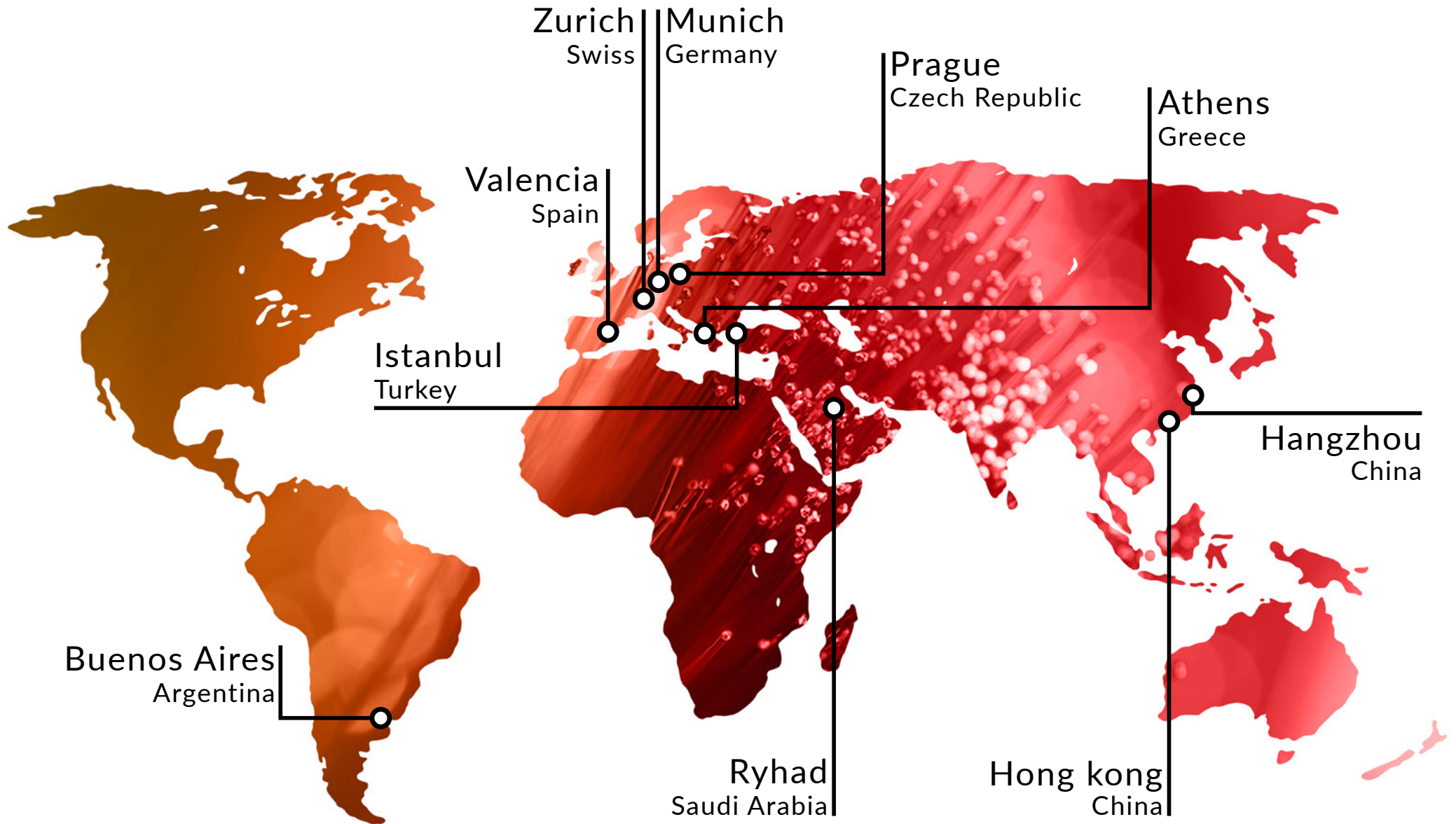

Main Customers

Out Line S.r.l.



Main Partners



Our R&D Department

Out Line S.r.l.



Our R&D Department

Out Line S.r.l.

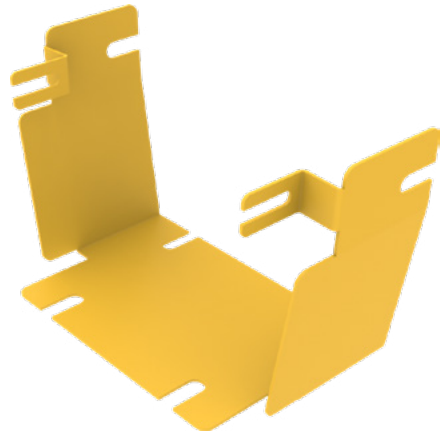

Fiber Duct Adapter Out Line - Panduit



PTE BT XL

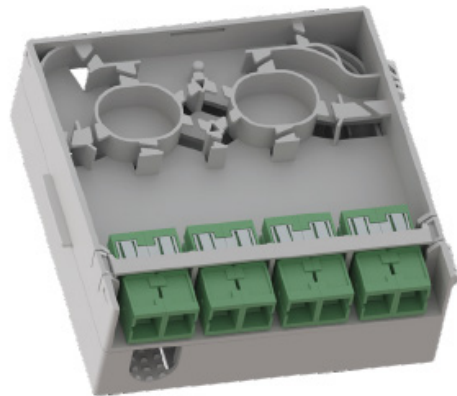

CDP



U-Shape

Our R&D Department

Out Line S.r.l.

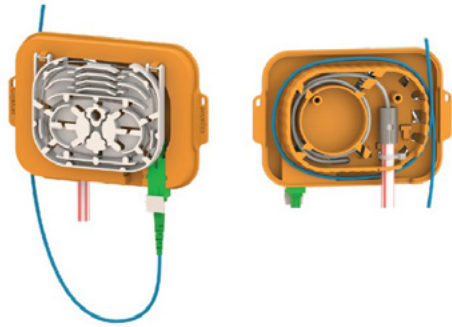

Wall Outlet (OTO)

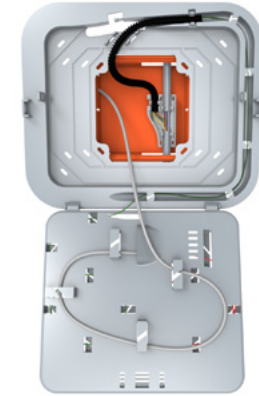
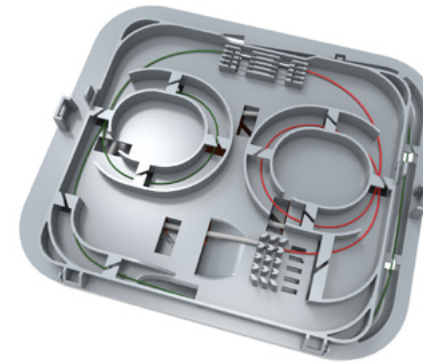

Floor Distribution Box

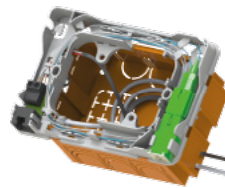
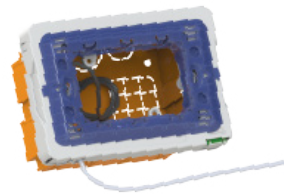

Wall Outlet Frame



PTE - OTB

Our R&D Department

Out Line S.r.l.

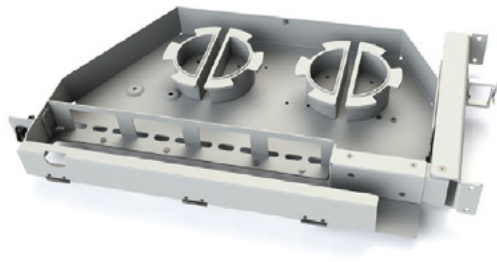

FO Subracks



ODF



PFS 288



Multi Operator Box



PFS 144



Data Office Structures

Our Products

Out Line S.r.l.

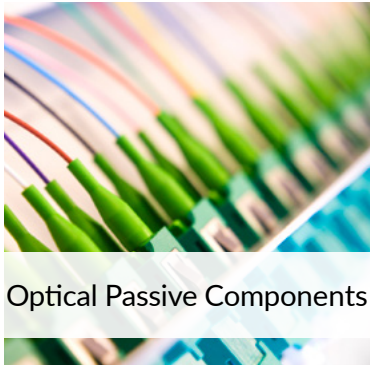

Optical Passive Components



Fiber Optical Cable

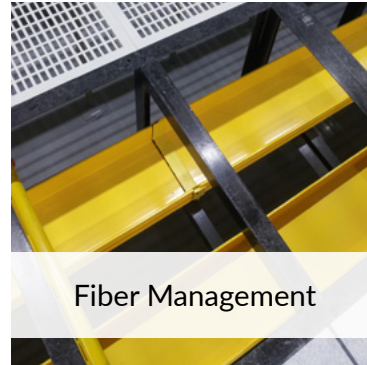

Fiber Management

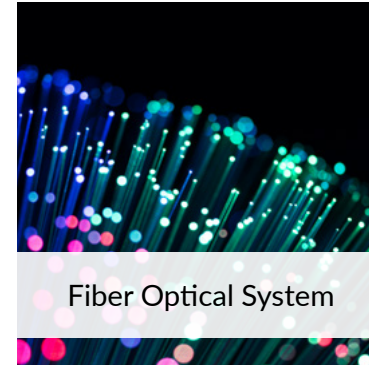

Fiber Optical System

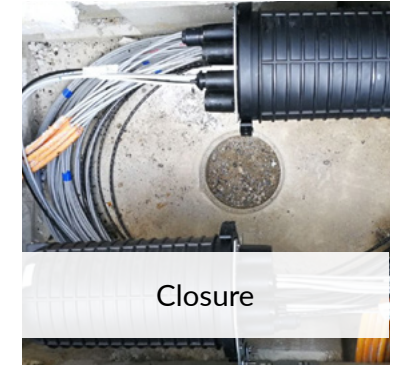

Closure

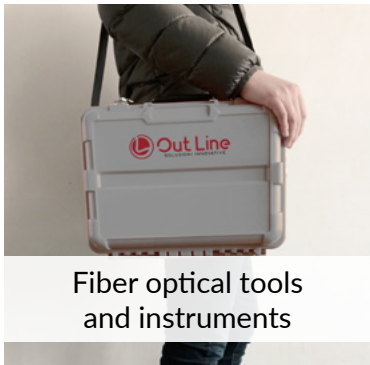

Fiber optical tools and instruments



Silway - FTTR System



Rack and Cabinet

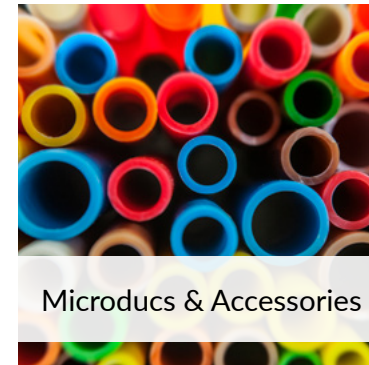

Microducts & Accessories

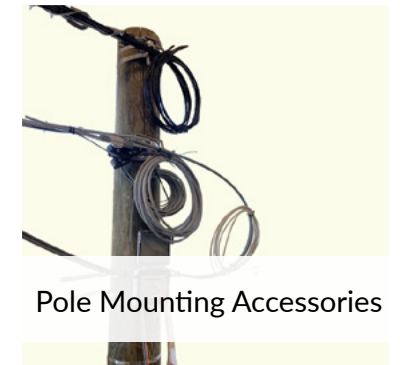

Pole Mounting Accessories

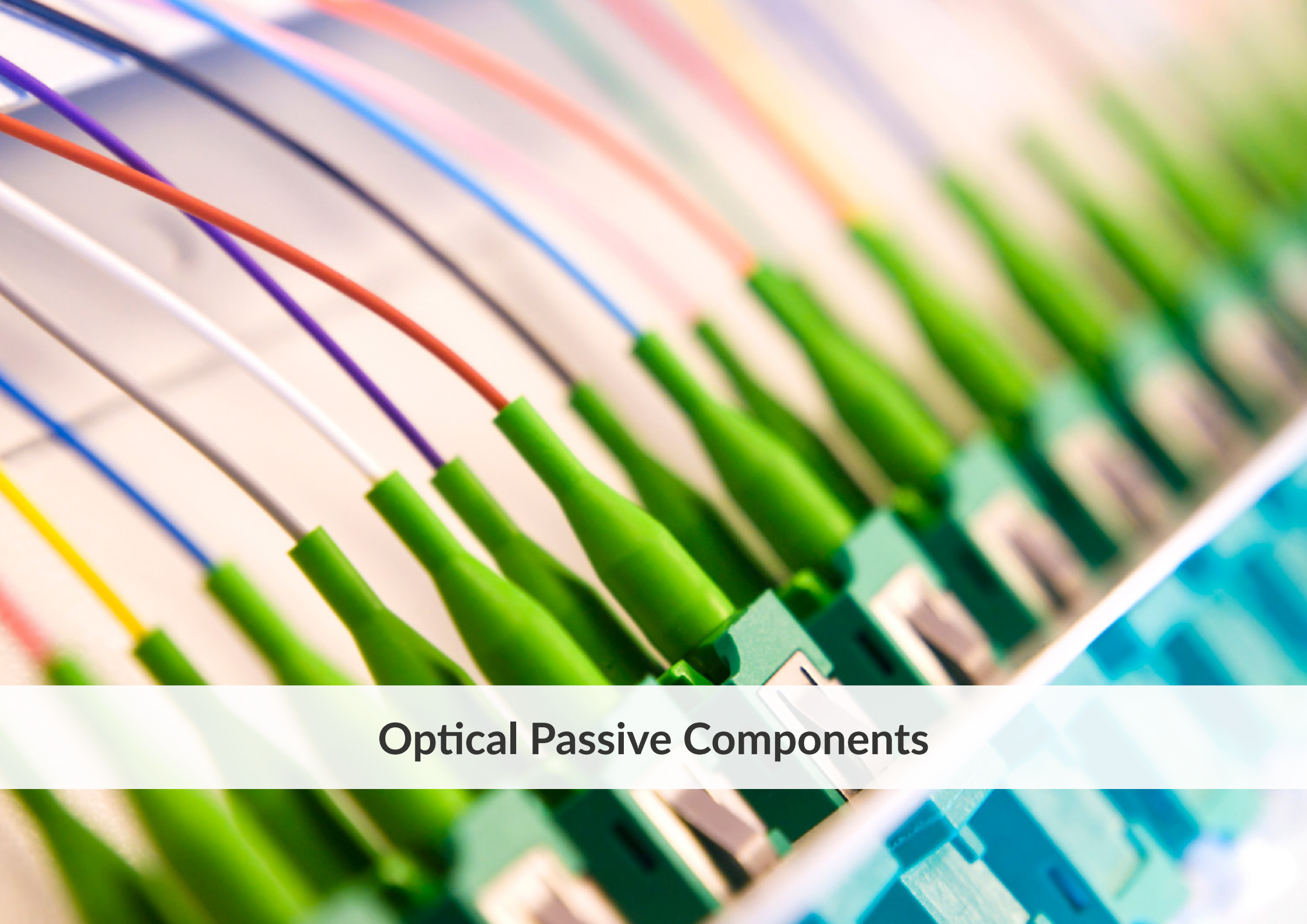

Optical Passive Components



Patch Cord

- FIBER OPTIC PATCHCORD
- FIBER OPTIC FAN-OUT AND TRUNK
- MPO PATCHCORD
- PATCHCORD SC/APC - SC/APC

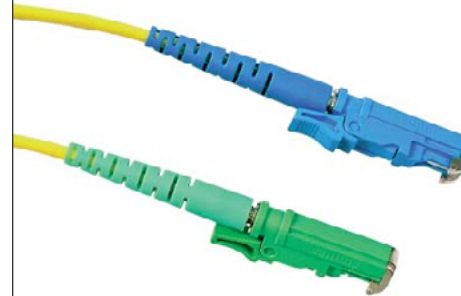

Pigtail Connector

- FIBER OPTIC PIGTAIL
- PIGTAIL WITH FBG 1650NM U BAND REFLECTOR EMBEDDED



WDM

- TIM: WDM GPON / XGS-PON
- CEX FILTER
- ENEL: WDM OTDR RING

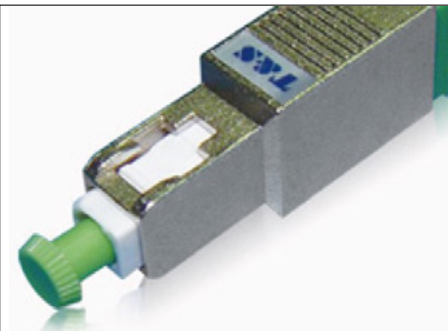

U-Band Reflector

- U-BAND REFLECTOR
- MONODIRECTIONAL FBG REFLECTOR
- BIDIRECTIONAL FBG REFLECTOR
- PIGTAIL WITH FBG 1650NM U BAND REFLECTOR EMBEDDED



Adapter

- FIBER OPTIC ADAPTER



Smart Adapter

- SM@D - SMART ADAPTER SYSTEM FOR USER RECOGNITION IN THE FIBER OPTICAL CABINETS



Attenuator

- FIBER OPTIC ATTENUATOR

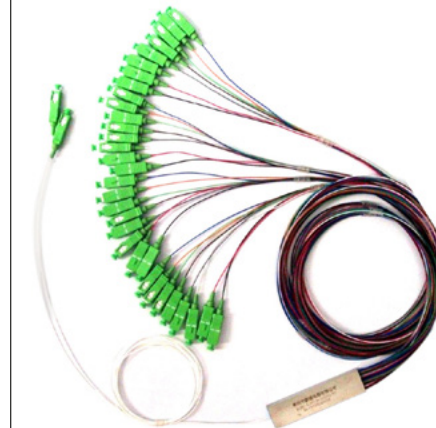

PLC Splitter

- 1XN & 2XN PLC SPLITTER
- MINI STEEL TUBE PLC SPLITTER
- 1XN & 2XN PLC SPLITTER
- PLC PRIMARY SPLITTER
- COMPACT SC/APC PRECONNECTORIZED PLC SPLITTER



WDM

- WAVELENGTH DIVISION MULTIPLEXING STEINLESS STEEL CASE
- WAVELENGTH DIVISION MULTIPLEXING PLASTIC CASE



Mechanical Splice

- FIBER OPTIC MECHANICAL SPLICE



Mechanical Connector

- SC/APC FAST MECHANICAL CONNECTOR



Splice-on Connector (SOC)

- SC/APC SPLICE-ON CONNECTOR



Fiber Optical Cables

FRP Cables 1/2 Fibers

- FRP CABLES 1/2 FIBERS

KFRP strength member or Steel wire
Optical fiber
Sheath

FRP Cables 8 Fibers

- FRP-CABLE-8-FIBERS

KFRP strength member or Steel wire
Optical fiber
Sheath

ADSS Cables

- 48..72 FIBERS
- 96 FIBERS
- 144 FIBERS
- 192 FIBERS

ADSS Drop Cables

- 24..48 FIBERS
- 4..12 FIBERS



Fiber Management

Fiber Management

Out Line S.r.l.

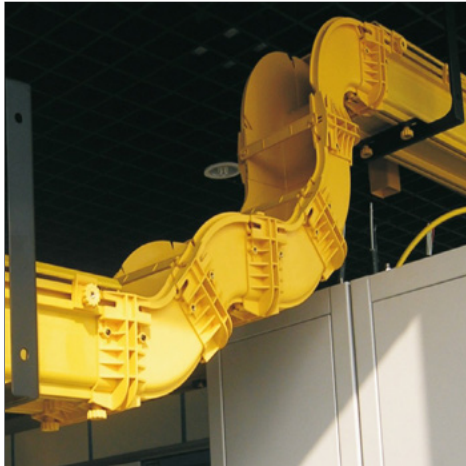

Fiber Optic Cable Ducts

- CABLE DUCT
- DUCT ACCESSORIES
- ADAPTER TO PANDUIT
- ADAPTER TO ADC KRONE

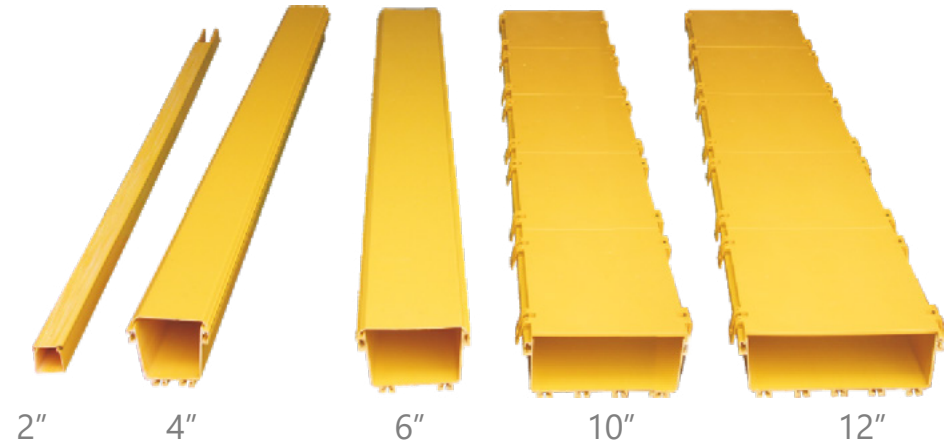



Fiber Optical System - FTTH



Wall Outlet

- 1 FO WALL OUTLET
- 2 FO WALL OUTLET
- 4 FO WALL OUTLET

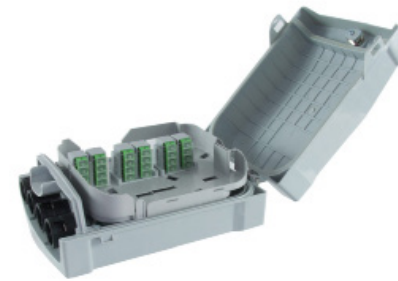

PTE BOXES

- 12 FO
- 24 FO
- 48 FO
- 72 FO



Frame Wall Outlet

- 1 FO WALL OUTLET
- 1 RJ11 INPUT



FTTH Accessories

- PRIMARY DIVIDER
- COMPACT FLOOR BOX
- SECONDARY DIVIDER

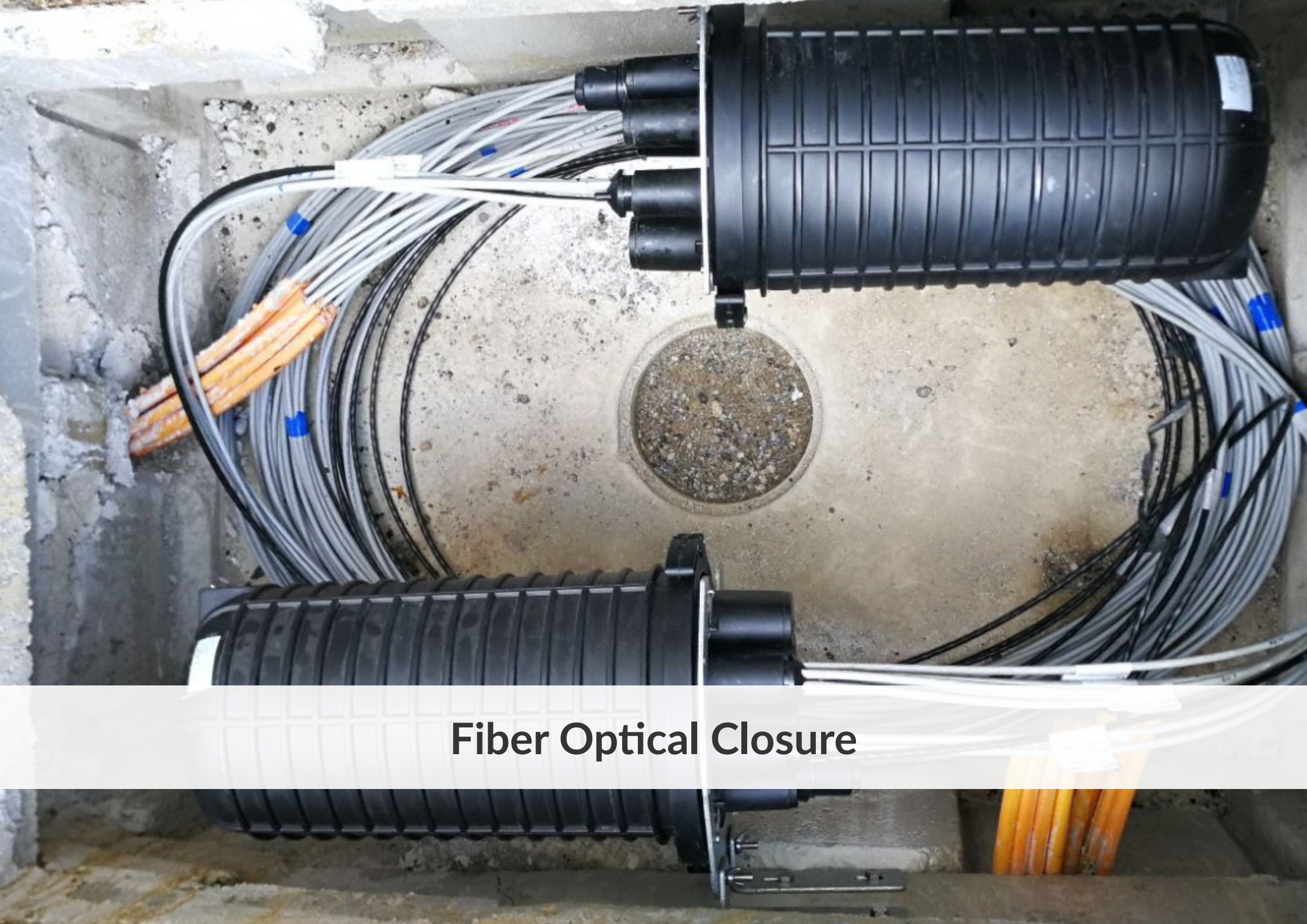

Fiber Optical Closure



Single Element (Fosc Type)

- SPLICE TRAYS AVAILABLE
- MINI CLOSURE
- DIFFERENT BASE AVAILABLE

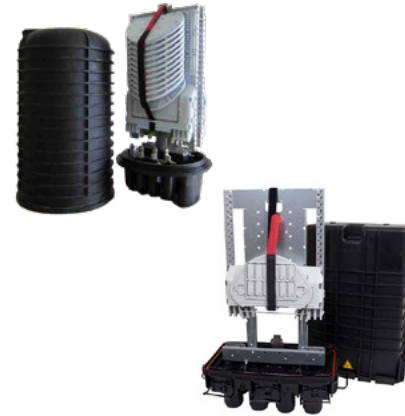

Single Circuit (Fist Type)

- ROUND CLOSURE
- SQUARE CLOSURE
- CUSTOMIZED CLOSURE

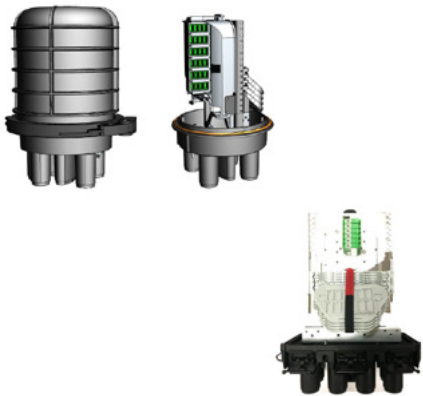

Single Circuit Point of Flexibility (Fist Type)

- ROUND CLOSURE
- SQUARE CLOSURE

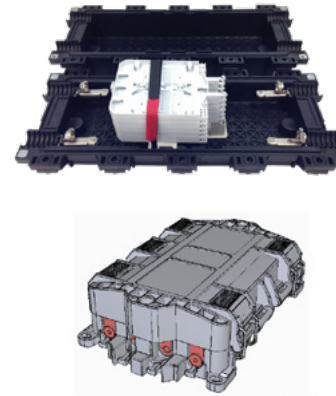

Inline Closure

- STANDARD INLINE CLOSURE
- CUSTOMIZED OF INLINE CLOSURE



Fiber Optical Tools and Instruments



Full Case for Jointers

- FIBER OPTICS - FULL CASE FOR JOINTERS



Cutting and Stripping Tools

- CUTTING AND STRIPPING TOOLS



Polishing Tools

- POLISHING TOOLS



Measuring Instruments OTDR

- FIBER OPTICS - MEASURING INSTRUMENTS OTDR



Easy Splicer

- EASY SPLICER - FTTH COMPACT AND FAST SPLICER MACHINE



740 FTTx Fusion Splicer

- 740 FTTX FUSION SPLICER



OTDR

- MEASURE DISTANCE FROM 0 TO 60 KM, IN RESOLUTION OF 1M
- MEASURE DB LOSS WITH A RESOLUTION OF 0.01 DB
- AUTO MODE FOR SUPER EASY OPERATION (AND EXPERT MODE FOR EXPERTS)
- 4.3 INCH, MULTI COLOR LED, TOUCH SCREEN



SILWAY - FTTR SYSTEM

SILWAY - FTTR System



Out Line S.r.l.

Designed and created by Out Line, SILWAY allows you to bring the optical fiber to every point of the apartment. The small and transparent profile allows you to pass the fiber in a simple and clean way where it is not possible to use the existing electrical system.

SILWAY guarantees the correct curvature of the optical fiber even in the presence of edges and corners.

This system allows everybody to create a protective path for cables in general up to 2.5mm in diameter with a minimum visual impact. Particularly it was designed for optical fibers.

The need arises from the frequent obstruction of junction boxes and corrugated pipes that do not allow the passage of delicate fiber optic cables.

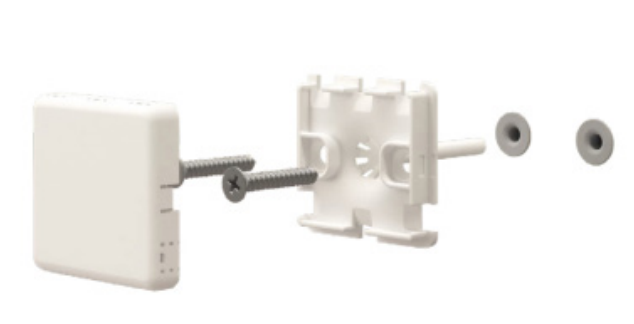
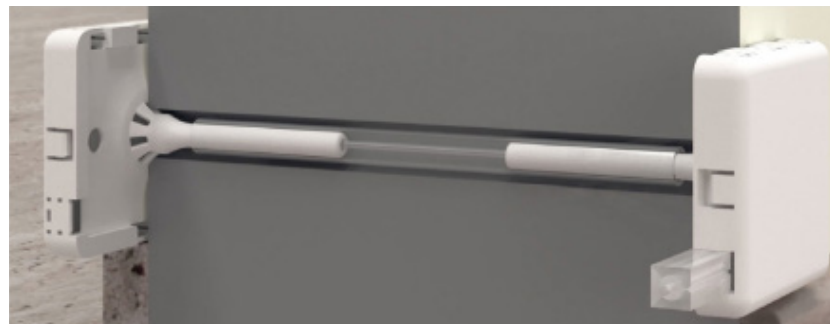
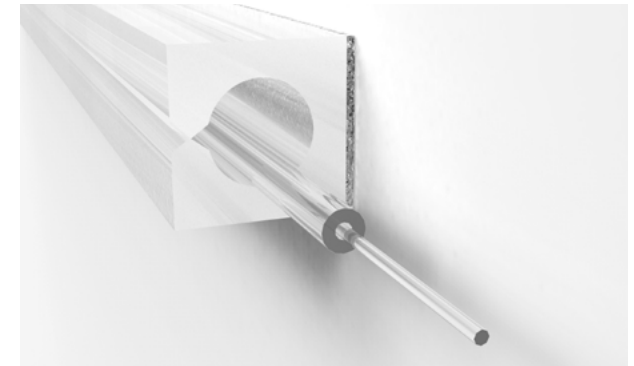
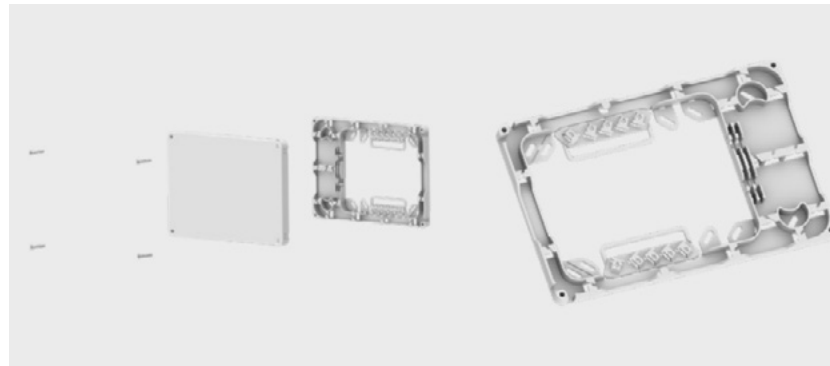

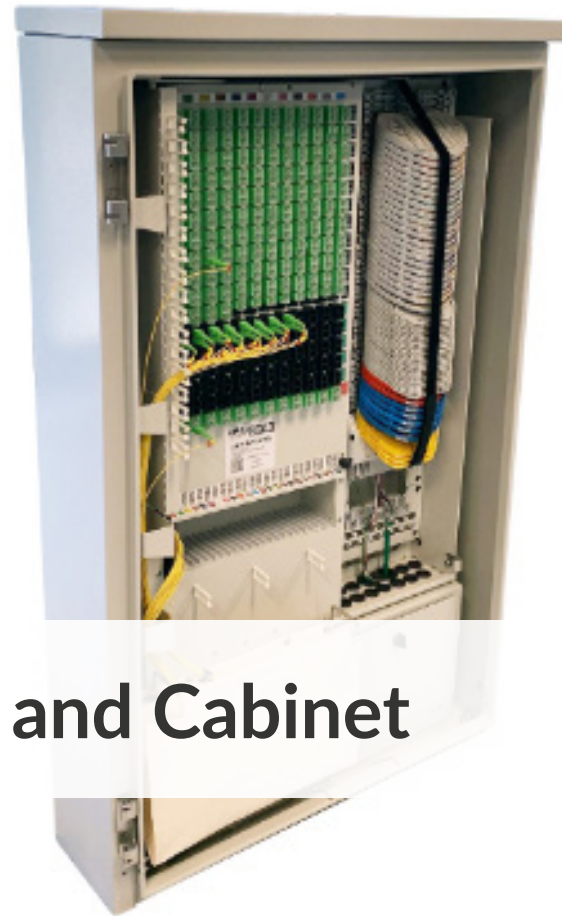

Fiber Optical Rack and Cabinet

Fiber Optical Rack and Cabinet

Out Line S.r.l.



ODF Rack

- DATA ROOM RACK
900X300X2.200 MM
- DATA ROOM RACK
1.200X300X2.200 MM



ETSI N3 Rack

- DATA ROOM RACK
600X300X2200MM

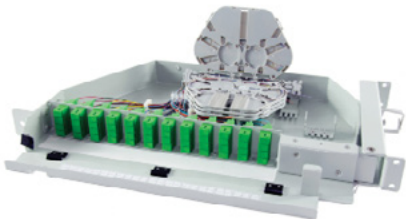

Junction/Termination Subrack

Up to 144 optical fibers

- PRE-CABLED SOLUTION



Junction/Termination Subrack

Up to 72 optical fibers

- EMPTY SOLUTION

Fiber Optical Rack and Cabinet

Out Line S.r.l.



Outdoor street cabinet for up to 256 users

- PFS4 OPEN FIBER 256U SC/APC CONFIGURATION
- CNO INFRATEL 256U SC/APC CONFIGURATION
- SCP PPC 256U SC/APC CONFIGURATION



Outdoor street cabinets for up to 576 users

- CRO FIBERCOP 384U SC/APC CONFIGURATION
- CRO FIBERCOP 576U SC/APC CONFIGURATION



Outdoor Pole/Wall cabinet for up to 288 users

- PFS 144U SC/APC CONFIGURATION
- PFS 288U SC/APC (WITH MPO CONNECTORS) CONFIGURATION
- NEW SCP 256U SC/APC POLE/STREET MOUNTING



Outdoor street cabinets for up to 128 users

- MINI-CRO FIBERCOP 128U SC/APC CONFIGURATION
- MINI-PFS 144U LC/APC CONFIGURATION

Fiber Optical Rack and Cabinet

Out Line S.r.l.



Extension Cabinet FTTC for outdoor

- FTTC EXTENSION CABINET 250W
- FTTC EXTENSION CABINET 300W



DSLAM Cabinet indoor

- DSLAM CABINET MEDIUM
- DSLAM CABINET LARGE



Microducts and Accessories

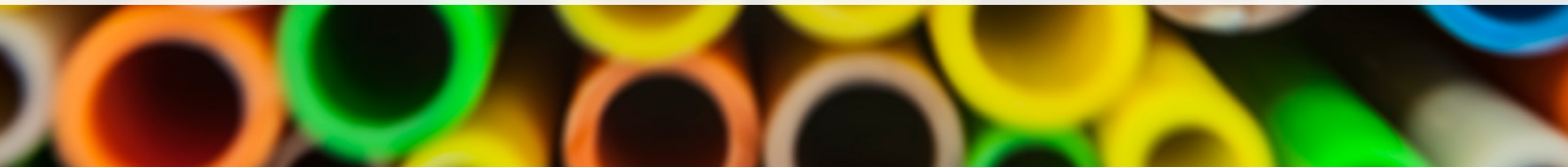



Microducts

- SINGLE SPEED-PIPES
- BUNDLES
- FENDER



Connectors

- 7 MM
- 10 MM
- 12 MM
- 14 MM
- 16 MM
- OTHER MEASURES UPON REQUEST



End Caps

- 7 MM
- 10 MM
- 12 MM
- 14 MM
- 16 MM
- OTHER MEASURES UPON REQUEST



Reducers

- 14/12 MM
- 12/10 MM
- OTHER MEASURES UPON REQUEST

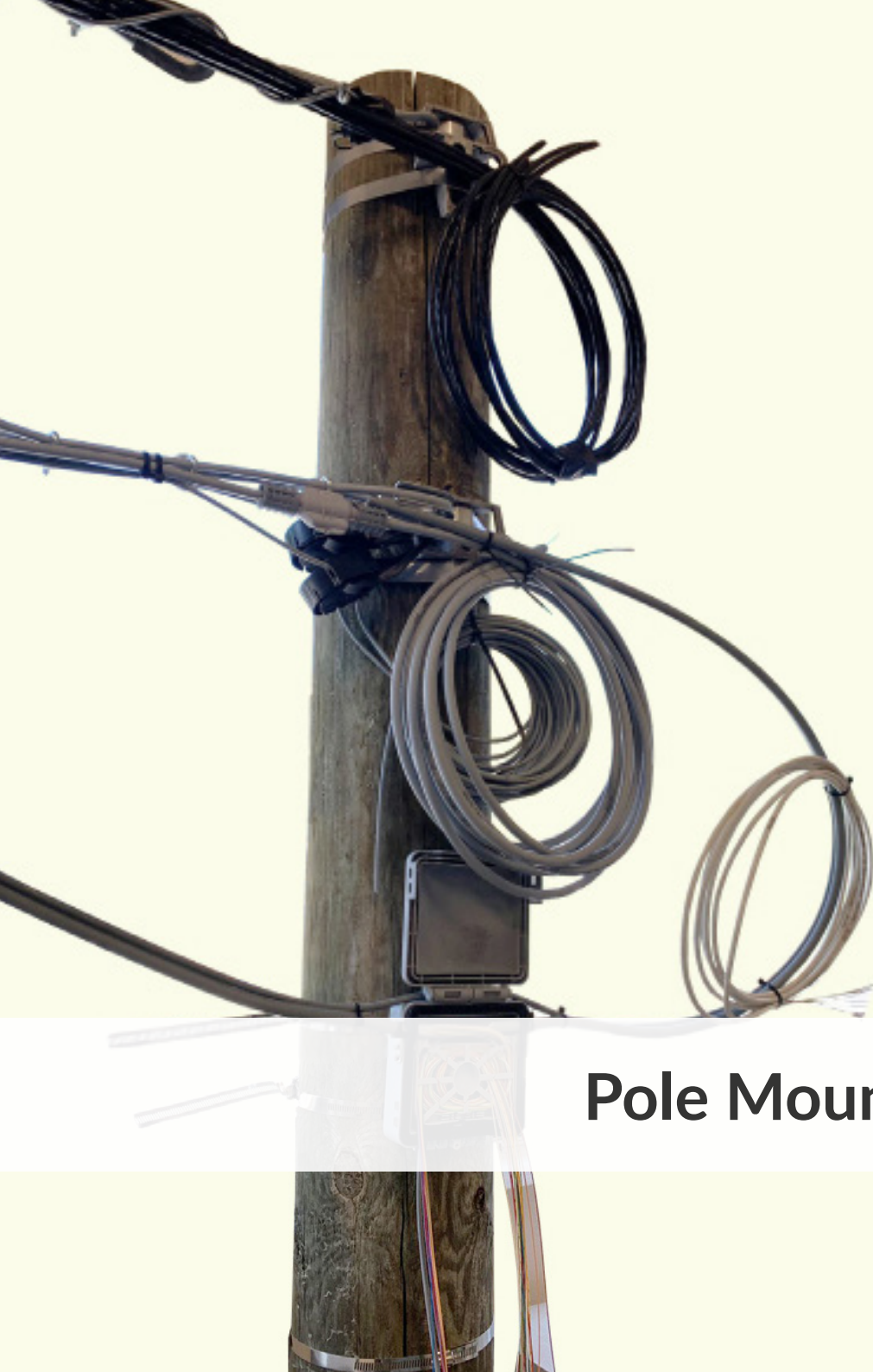

Pole Mounting Accessories



2/4HH Aerial Divider

- FIBER DISTRIBUTION BOX FOR 2/4 UI FOR AERIAL OR WALL INSTALLATION



6HH Aerial Divider

- FIBER DISTRIBUTION BOX FOR 6 UI FOR POLE OR WALL INSTALLATION

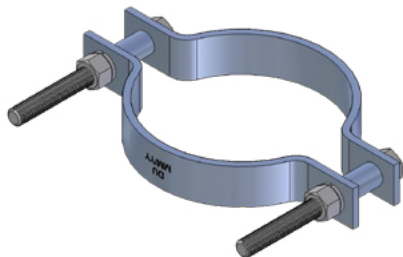

Steel Collar

- THE ELLIPTICAL COLLAR IS PLACED ON TOP OF THE FIBERGLASS POLES AND WOODEN POLES. IT PERFORMS THE TASK OF CONNECTING ACCESSORIES SUCH AS THE CHAIN TENSIONER

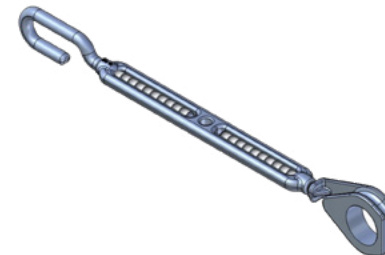

Metallic Tie-Rod with integrated thimble

- THE HOOK FOR ANCHORING TO THE POLE RING AND THE INTEGRATED THIMBLE THAT ALLOWS THE PASSAGE OF THE ANCHORING CLAMP

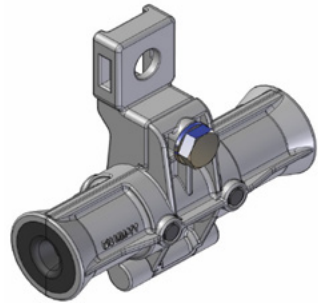

Accessories for Suspension TYPE A

- THE TYPE A SUSPENSION DEVICE IS SUITABLE FOR SUPPORTING THE SELF-SUPPORTING OPTICAL CABLE WITH A DIAMETER OF 13 ± 0.5 MM TO THE SUPPORT POLES WITHOUT TENSION OR WITH LIMITED AXIAL TENSIONS AND ENSURES THE ANCHORING OF THE CABLE



Accessories for Suspension OF

- THE OPEN FIBER SUSPENSION DEVICE IS SUITABLE FOR SUPPORTING THE SELF-SUPPORTING OPTICAL CABLE WITH A DIAMETER OF 13 ± 0.5 MM TO THE SUPPORT POLES WITHOUT TENSION OR WITH LIMITED AXIAL TENSIONS AND ENSURES THE ANCHORING OF THE CABLE



Accessory for Mooring

- SUPPORT ELEMENT FOR OVERHEAD LAYING OF CABLES. CONSISTING OF A TIE ROD AND SUCTION FILAMENTS CAPABLE OF WRAPPING AND SUPPORTING THE CABLE



U-SHAPE

- THE U-SHAPE FIBER SLACK STORAGE DEVICE IS THE PROTECTION FOR ADSS AND STANDARD CABLES INSTALLED ON WOODEN OR CONCRETE POLES

A series of 20 horizontal lines for writing.



Address:

Out Line S.r.l. via degli Olmetti 39D
00060 Formello (RM)

Phone:

+39 0690405273

Email:

commerciale@outline.company

www.outline.company